

# QUICK START GUIDE



VD200M

# Installing Vehicle Docking

## Overlook of Vehicle Docking

Front side:

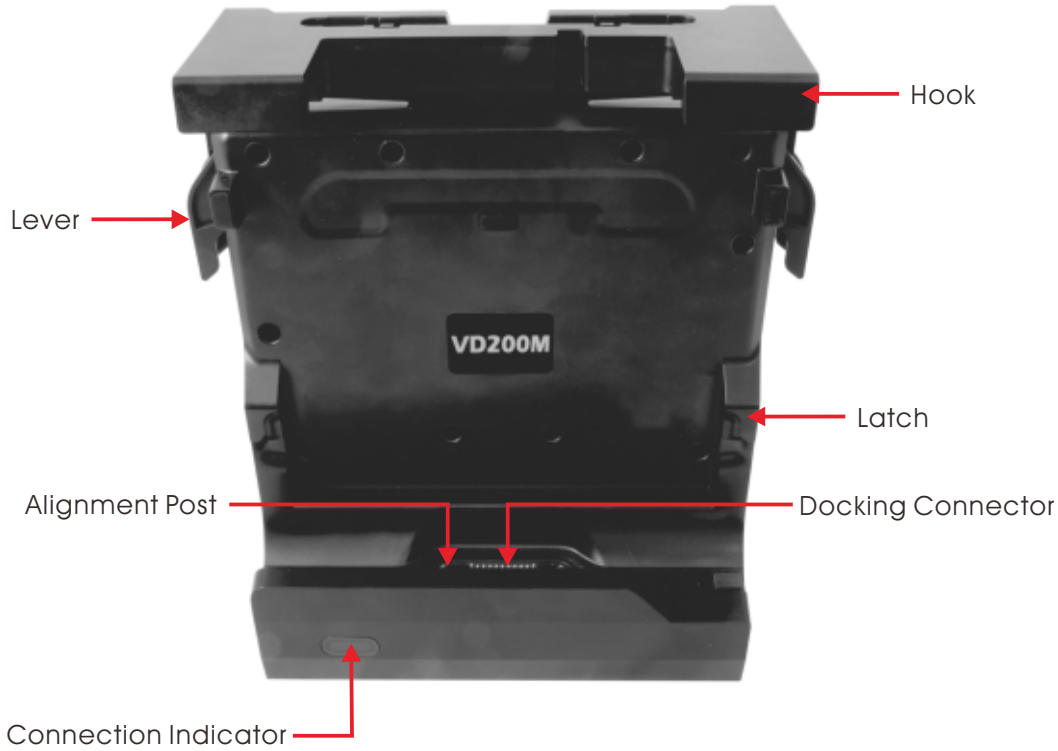

Back side:

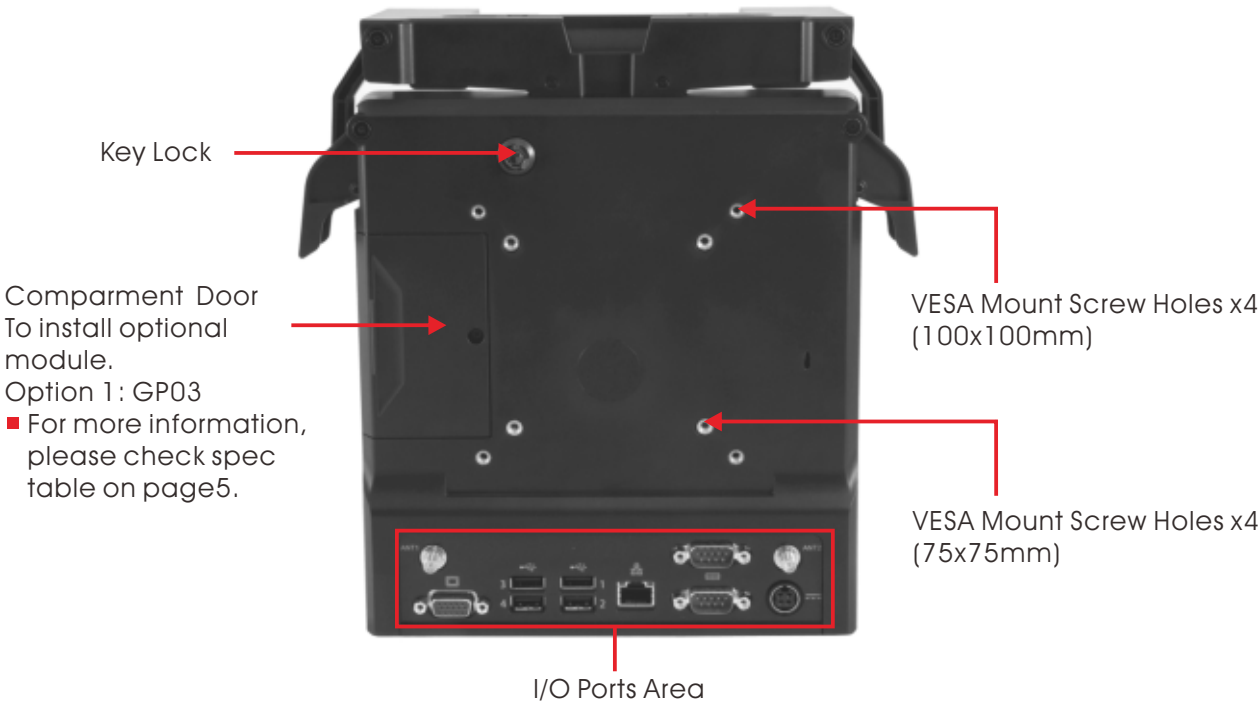

# I/O Ports Define:

VD200M

To be the GPS antenna Connector when GP03 is installed.  
\*Default is no function.

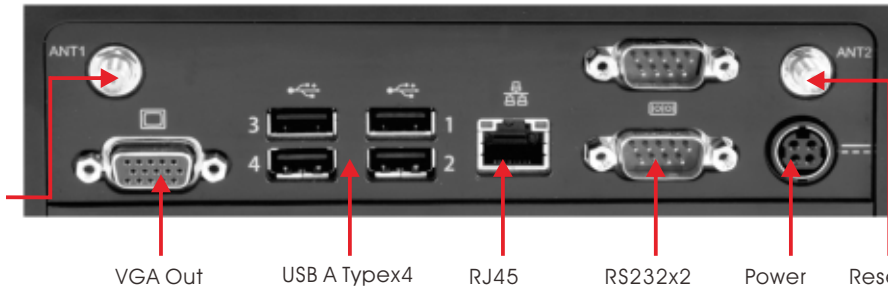

## Getting Start:

1. Flip levers upward on both sides

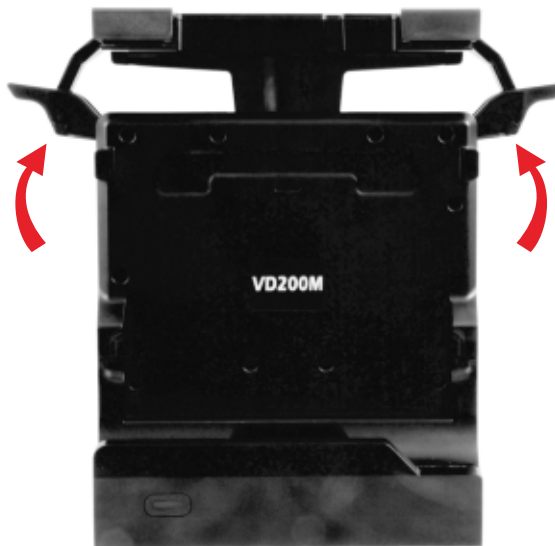

2. Align grooves on the bottom of tablet with docking alignment posts and push downward

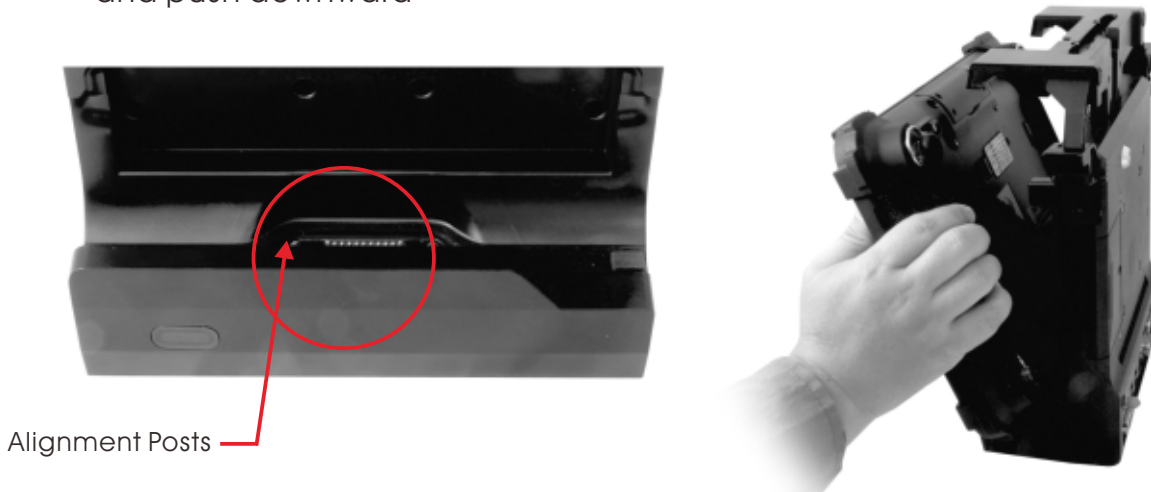

3. Push tablet forwards and make sure tablet is well connected and fixed with latches.



4. Press down levers on both sides at the same time.

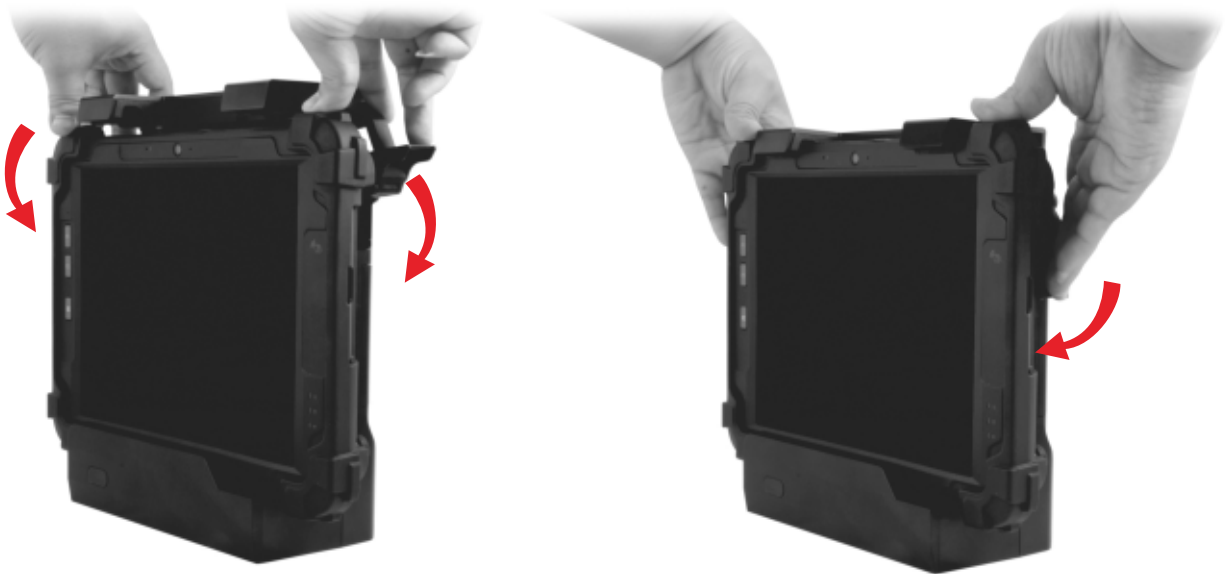

5. Check connection indicator to make sure tablet is in the right position.



## Connecting Power Cord With Cigar Lighter Plug

1. Connect power plug with DC-IN jack.
2. Insert cigar lighter adapter into car lighter.



## Connecting Power Cord With ACC Plug

1. Connect power plug with DC-IN jack.
2. Connect the other side of ACC cord with car accumulator



## Secure tablet with key lock

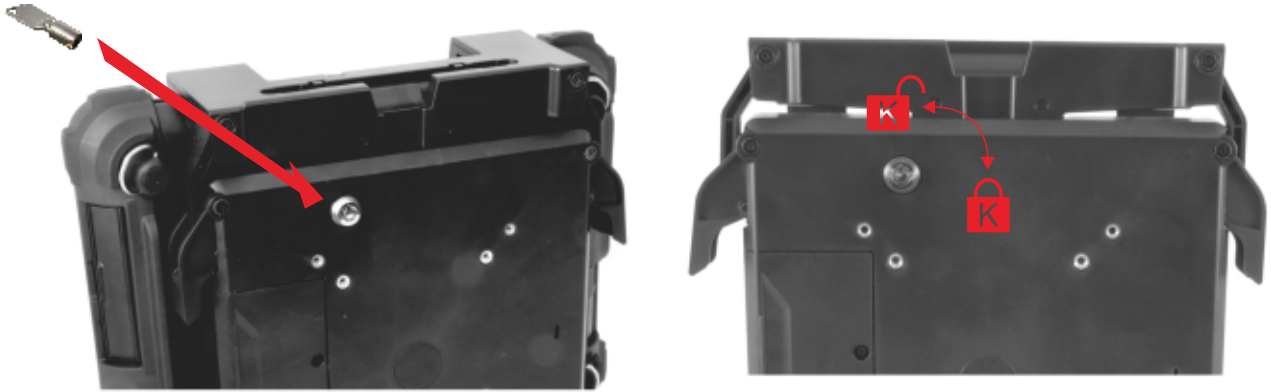

## Spec

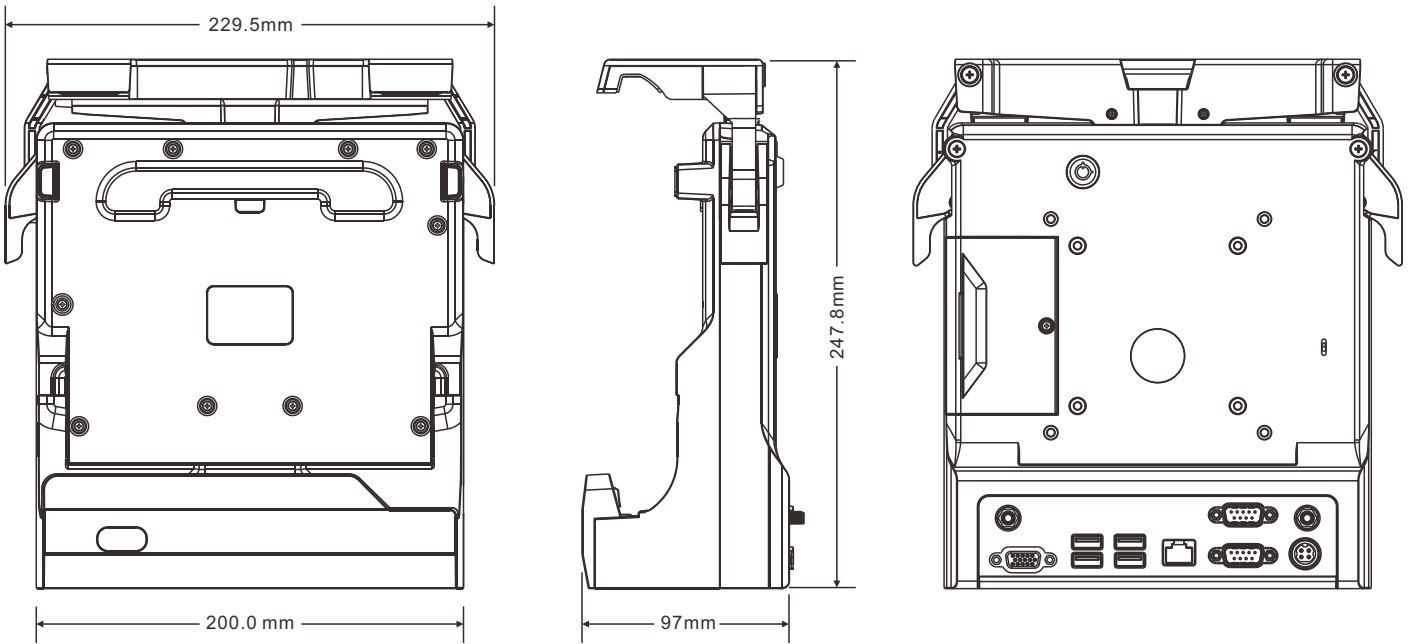

I/O Interface	4xUSB 2.0 type A, 1xEthernet, 2x RS232, 1x VGA, 1x DC-IN
Mounting System Screw Holes	75mm x 75mm and 100mm x 100mm VESA mount supported (* Mount is not included.)
Output Power	19V @ 1.57A Max., total output 30W
Input Power	9VDC to 32VDC
Power Cord	Cigar lighter plug and ACC plug power cords
LED	1x single Color LED (Blue)
Optional Module	GP03: Provide GPS signal to tablet.